

# Replacement Parts

Issue Date: 10/2024

## CONTENTS

- 
- |    |  |    |                                      |
|----|--|----|--------------------------------------|
| 2  | STARSystem                             | 12 | Clinician Arm Support                |
| 5  | IR System                              | 13 | <i>MR Safe</i><br>Adducted Arm Scoop |
| 6  | ArmSure                                | 14 | Head Immobiliser                     |
| 7  | <i>MR Safe</i><br>Overhead Arm Support |    |                                      |
| 8  | Antegrade IR Platform                  |    |                                      |
| 8  | Drape Support                          |    |                                      |
| 9  | Retrograde IR Platform                 |    |                                      |
| 10 | Lower Leg Support                      |    |                                      |
| 11 | Prone Support                          |    |                                      |

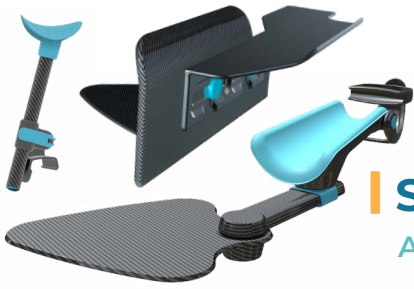

## STARSystem

AM0160- AM0100 - AM0140

### Component Codes

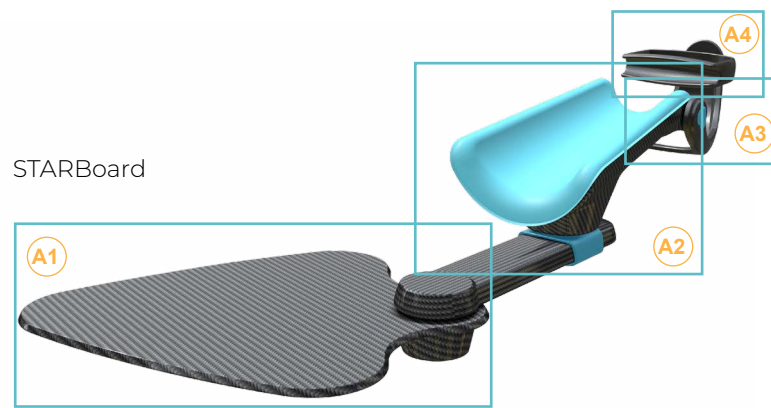

**(BC)** STARTable

**(D)** STARSupport



## STARBoard

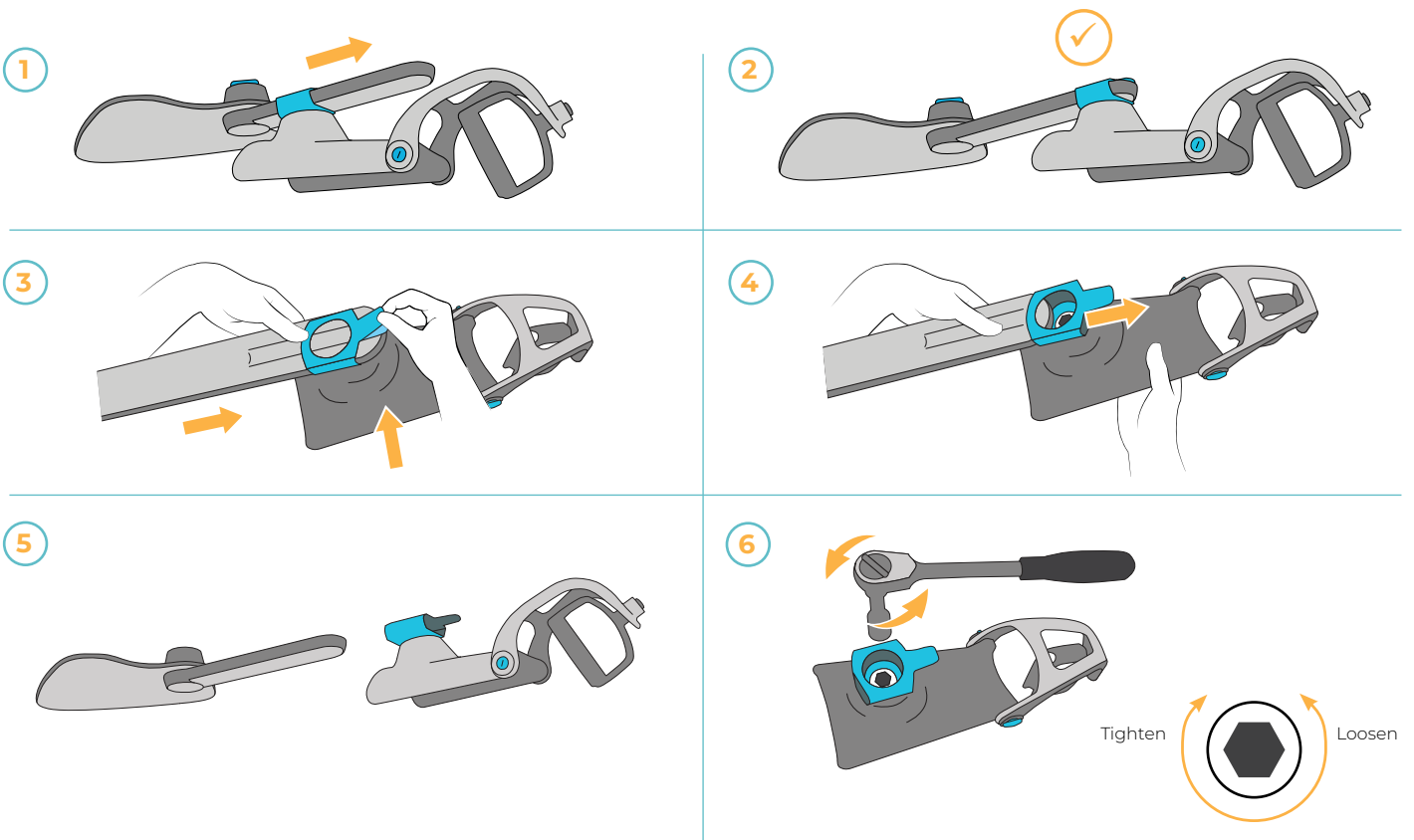

## STARBoard Component Codes

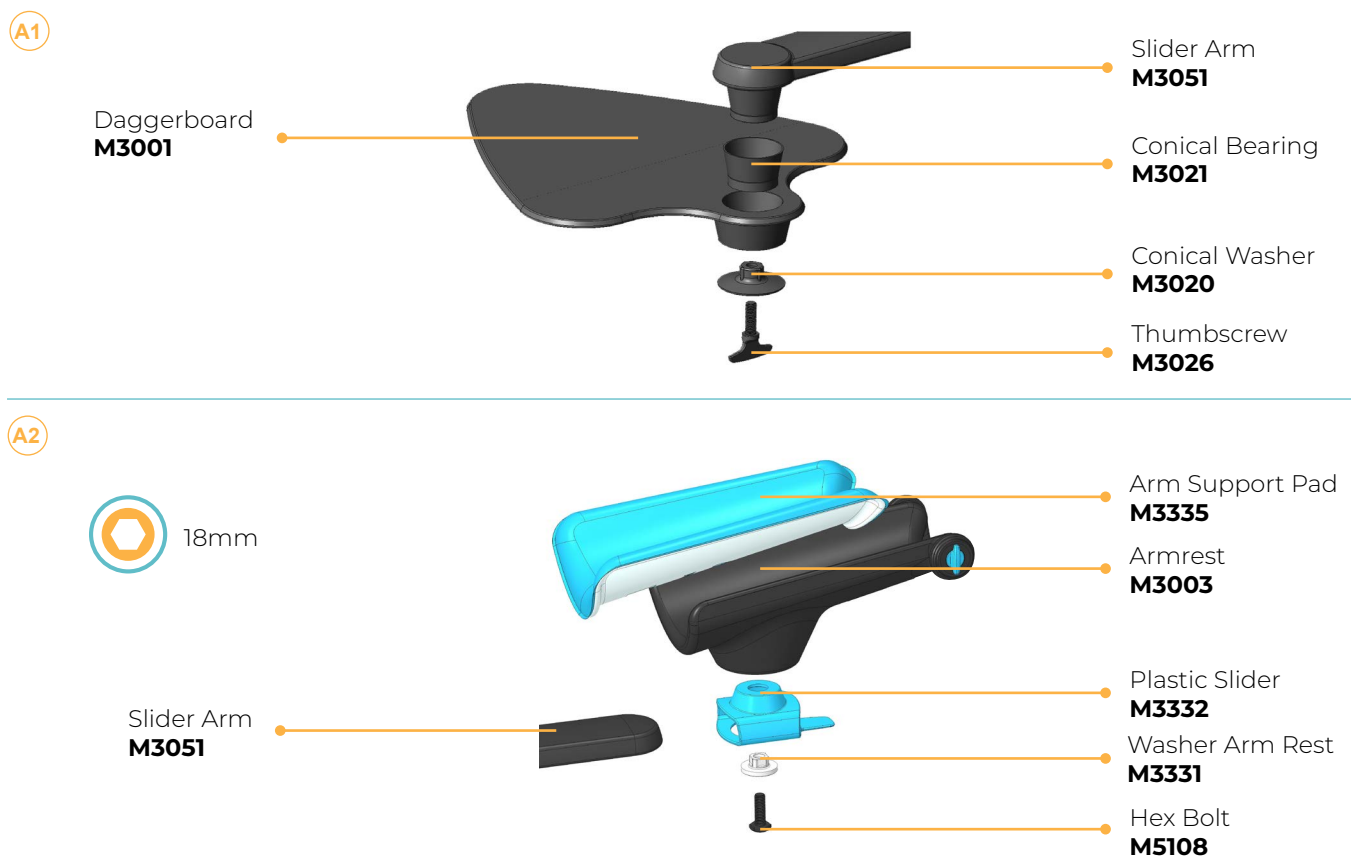

**A3**

Thumbscrew Wrist Pivot

**M3025**

Wrist Pivot Cone

**M3094**

Wrist Pivot

**M3052**



**A4**



18mm

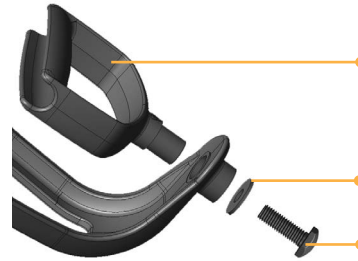

Handle  
**M3072**

Washer Handle  
Spigot  
**M3030**

Hex bolt  
**M5108**

### STARTable

**BC**



STARTable Shelf  
**M3130**

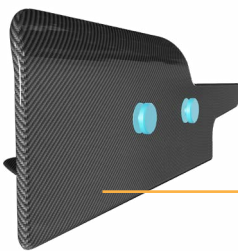

STARTable Shield  
**M3140**

### STARSupport

**D**



Left Arm Support  
Tube Assembly  
**M3333**

Swivel Clamp Assembly  
**M3059**

### Maintenance instructions:





[adeptmedicaltraining.com  
/product-maintenance-starsystem](https://adeptmedicaltraining.com/product-maintenance-starsystem)



**IR System**  
AM0180 - AM0500

**Component Codes**

| Product   | Name           | Code   |
|---|----------------|--------|
|    | Extension Tray | M3334  |
|   | X-Ray Shield   | AM0630 |
|  | Daggerboard    | M3677  |

STARBoard  
(Refer to page 3-4)

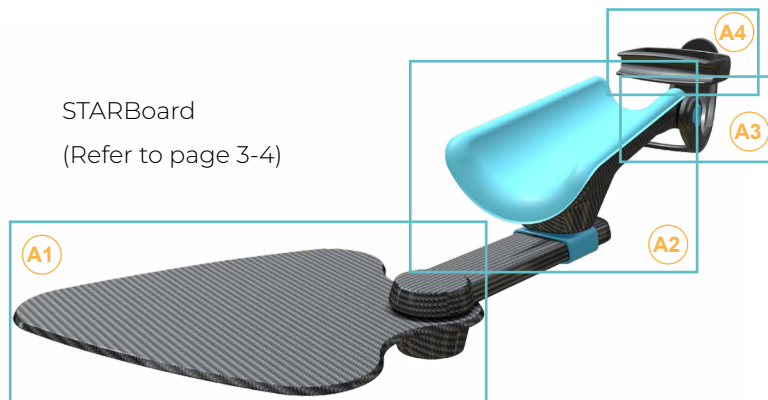



## ArmSure

AM0640 - AM0610

### Component Codes

| Component   |          | Name           | Code   |
|---|----------|----------------|--------|
|  | <b>A</b> | Arm Support    | M5109  |
|  | <b>B</b> | Arm Strap x 10 | AM0620 |
|  | <b>C</b> | Arm Support XR | M5101  |
|  | <b>D</b> | X-Ray Shield   | AM0630 |



MR Safe  
**Overhead Arm Support**  
AM4000

Component Codes





| Component   |          | Name                         | Code   |
|---|----------|------------------------------|--------|
|  | <b>A</b> | Armrest Wing MR Safe         | M5504  |
|  | <b>B</b> | Arm Strap x 10               | AM0620 |
|  | <b>C</b> | Locking Leg Assembly MR Safe | M5505  |
|  | <b>D</b> | Daggerboard MR Safe          | M5506  |

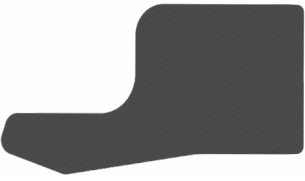

## Antegrade IR Platform

AM0440

### Component Codes

| Component   |          | Name                    | Code  |
|---|----------|-------------------------|-------|
|    | <b>A</b> | Antegrade Main Platform | M6500 |
|   | <b>B</b> | Base                    | M6521 |
|  | <b>C</b> | Leg                     | M3664 |
|  | <b>D</b> | Leg Extension           | M3693 |



## Drape Support

AM1000

### Component Code

| Product   | Name          | Code   |
|---|---------------|--------|
|  | Drape Support | AM1000 |







## Retrograde IR Platform

AM0400 - AM0410 - AM0420

### Component Codes



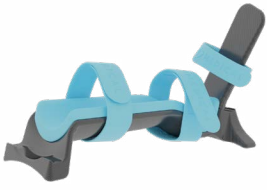



| Component   |          | Name                     | Code   |
|---|----------|--------------------------|--------|
|  | <b>A</b> | Retrograde Main Platform | M3660  |
|  | <b>B</b> | Front Base               | M3662  |
|  | <b>C</b> | Rear Base                | M3663  |
|  | <b>D</b> | Leg                      | M3664  |
|  | <b>E</b> | Leg Extension            | M3693  |
|  | <b>F</b> | Extension                | AM0410 |



## Lower Leg Support

AM3000

### Component Codes

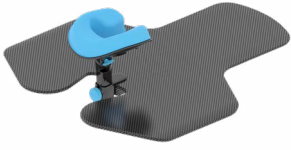

| Component   |          | Name         | Code  |
|---|----------|--------------|-------|
|   | <b>A</b> | Foot Plate   | M6511 |
|  | <b>B</b> | Leg Pad      | M6512 |
|  | <b>C</b> | Support Base | M6516 |
|  | <b>D</b> | Leg Strap    | M6513 |
|  | <b>E</b> | Foot Strap   | M6514 |
|  | <b>F</b> | Table Strap  | M6515 |



## Prone Support

AM0700

### Component Codes

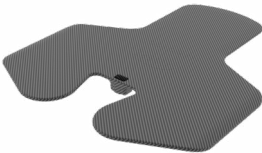
| Component   |          | Name                | Code  |
|---|----------|---------------------|-------|
|   | <b>A</b> | Face Pad            | M6531 |
|  | <b>B</b> | Face Pad Support    | M6532 |
|  | <b>C</b> | Adjustable Assembly | M6533 |
|  | <b>D</b> | Base Board          | M6534 |



## Clinician Arm Support

AM0900

### Component Codes

| Component   |          | Name                | Code  |
|---|----------|---------------------|-------|
|    | <b>A</b> | Arm Support Pad     | M3335 |
|   | <b>B</b> | Forearm Assembly    | M9120 |
|  | <b>C</b> | Base Board Assembly | M9100 |

### Tube Assembly

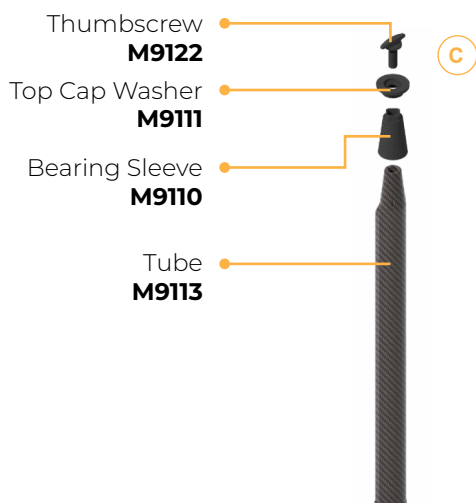

### Forearm Assembly (M9120)

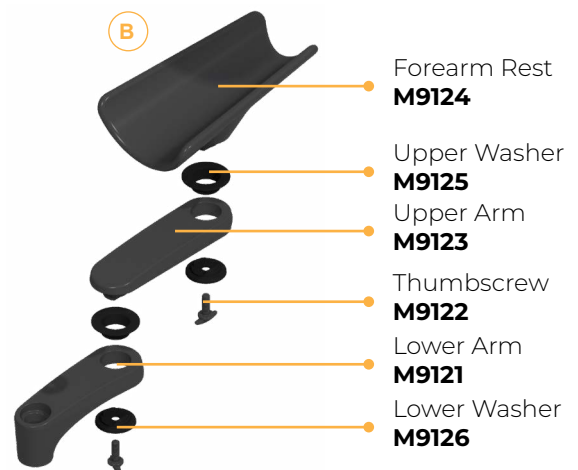





## Adducted Arm Scoop

AM1100

### Component Codes



| Component   |   | Name                     | Code  |
|---|---|--------------------------|-------|
|  |  | Adducted Arm Support x 1 | M6555 |



# Head Immobiliser

AM0800

## Component Codes

| Component   |          | Name                                 | Code   |
|---|----------|--------------------------------------|--------|
|    | <b>A</b> | Base Board Assembly                  | M8000  |
|    | <b>B</b> | Base Board                           | M8100  |
|   | <b>C</b> | Hood Support                         | M8200  |
|  | <b>D</b> | Adjustable Assembly                  | M8300  |
|  | <b>E</b> | Forehead Straps x 10                 | M8400  |
|  | <b>F</b> | Hood Assembly + Forehead Straps x 10 | AM0820 |

## Maintenance instructions:

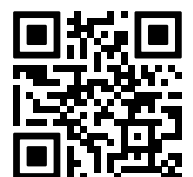
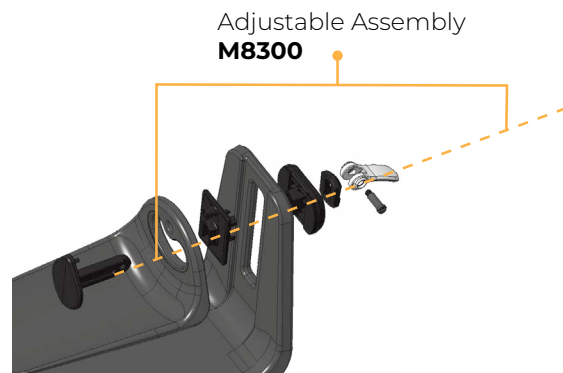
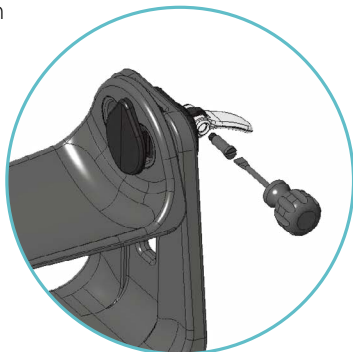

[adeptmedicaltraining.com  
/product-maintenance-headimmobiliser](https://adeptmedicaltraining.com/product-maintenance-headimmobiliser)