

Product Codes & Maintenance

Issue Date: 04/2025

CONTENTS

Product & Component Codes • Carton Dimensions & Weight • Maintenance

- | | | | |
|----------------|-----------------------------|----------------|--------------------------------|
| <i>MR Safe</i> | 2 Adducted Arm Scoop | <i>MR Safe</i> | 10 Overhead Arm Support |
| 3 | Antegrade IR Platform | 11 | Prone Support |
| 4 | Clinician Arm Support | 12 | Retrograde IR Platform |
| 5 | Drape Support | 14 | STARSystem |
| 6 | Head Immobiliser | | |
| 8 | IR System | | |
| 9 | Lower Leg Support | | |



adeptmedical.co.nz/repairs

Visit our website for our Statement of Warranty:
adeptmedical.com/post/adept-medical-statement-of-warranty



MR Safe
Adducted Arm Scoop
AM1100

Product Code			Carton Dimensions L x W x H (cm)	Carton Weight (kg)
	Adducted Arm Scoop x 2	AM1100	66 x 35 x 14	2.7

Component Code

	Adducted Arm Support x 1	M6555
---	--------------------------	-------







Antegrade IR Platform

AM0440

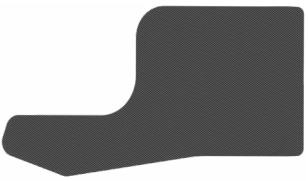
Product Code		Carton Dimensions L x W x H (cm)	Carton Weight (kg)	
	Antegrade IR Platform	AM0440	145 x 76 x 9	14.5

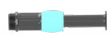
Component Codes

	Antegrade Main Platform	M6500
	Base	M6521
	Leg	M3664
	Leg Extension	M3693



Clinician Arm Support

AM0900

Product Code			Carton Dimensions L x W x H (cm)	Carton Weight (kg)
	Clinician Arm Support	AM0900	18 x 52 x 46	3.3

Component Codes

	Arm Support Pad	M3335
	Forearm Assembly	M9120
	Base Board Assembly	M9100

Tube Assembly

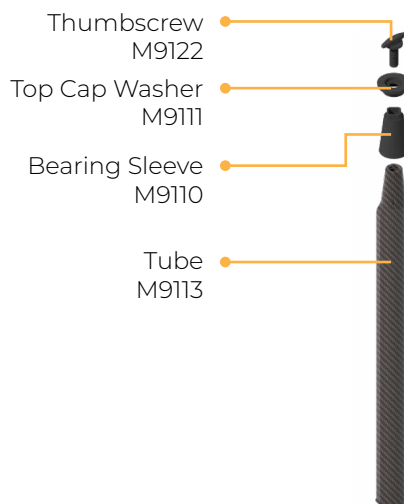

Forearm Assembly (M9120)

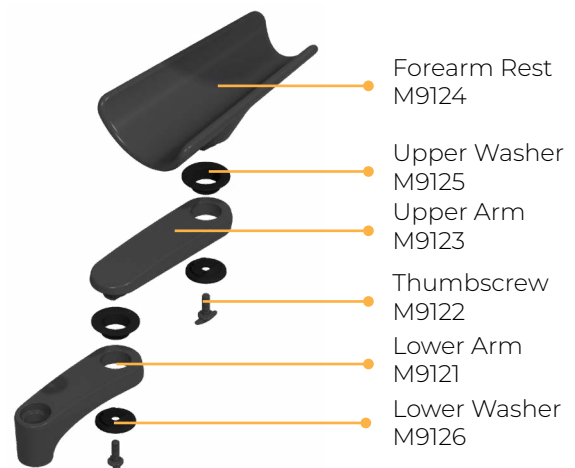



Drape Support

AM1000

Product Code			Carton Dimensions L x W x H (cm)	Carton Weight (kg)
	Drape Support	AM1000	37 x 33 x 23	2.6

Component Codes

No spare parts available for this product. For breakages outside of our warranty, please contact us at adeptmedical@adept.co.nz to purchase a full product replacement.



Head Immobiliser

AM0800

Product Code			Carton Dimensions L x W x H (cm)	Carton Weight (kg)
	Head Immobiliser	AM0800	94 x 30 x 50	7

Component Codes

	Base Board Assembly	M8000
	Base Board	M8100
	Hood Support	M8200
	Adjustable Assembly	M8300
	Forehead Straps x 10	AM0830
	Hood Assembly + Forehead Straps x 10	AM0820

Maintenance Instructions

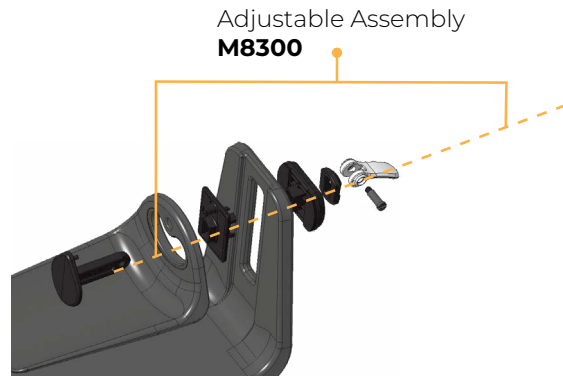
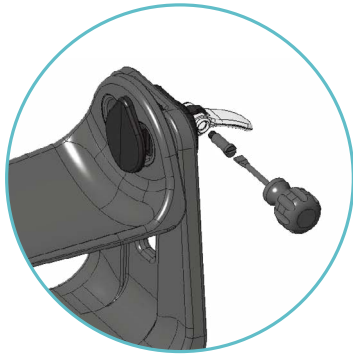



▶ [adeptmedicaltraining.com
/product-maintenance-headimmobiliser](https://adeptmedicaltraining.com/product-maintenance-headimmobiliser)







IR System

AM0180 - AM0500

Product Codes	Carton Dimensions L x W x H (cm)	Carton Weight (kg)
 <p>IR System</p> <p>AM0500 + AM0180</p>	50 x 37 x 31	5
 <p>STARBoard + Extension Tray</p> <p>AM0180</p>	50 x 37 x 24	3.2
 <p>IR Shield</p> <p>AM0500</p>	50 x 37 x 7	2.5
 <p>Arm Support Pad</p> <p>AM0171</p>	32 x 18 x 9	0.5

Component Codes

 <p>STARBoard</p> <p>Refer to page 15</p>
 <p>Extension Tray</p> <p>M3334</p>
 <p>X-Ray Shield</p> <p>AM0630</p>
 <p>Daggerboard</p> <p>M3677</p>

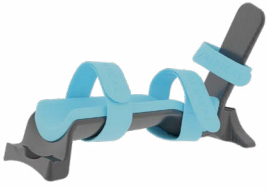

Lower Leg Support

AM3000



Product Code	Carton Dimensions L x W x H (cm)	Carton Weight (kg)		
	Lower Leg Support	AM3000	61 x 29 x 13	3.3

Component Codes





	Foot Plate	M6511
	Leg Pad	M6512
	Support Base	M6516
	Leg Strap	M6513
	Foot Strap	M6514
	Table Strap	M6515



MR Safe
Overhead Arm Support
AM4000 - AM4100

Product Codes			Carton Dimensions L x W x H (cm)	Carton Weight (kg)
	Overhead Arm Support MR Safe	AM4000	60 x 44 x 14	3.5
	Overhead Arm Support MR Safe - Small	AM4100	60 x 44 x 14	3.5

Component Codes

	Armrest Wing MR Safe	M5504
	Armrest Wing MR Safe - Small	M5507
	Arm Strap x 10	AM0620
	Locking Leg Assembly MR Safe	M5505
	Daggerboard MR Safe	M5506



Prone Support

AM0700

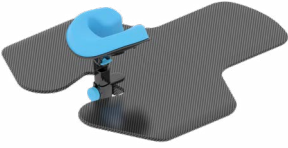
Product Codes			Carton Dimensions L x W x H (cm)	Carton Weight (kg)
	Prone Support	AM0700	80 x 77 x 11	5.1

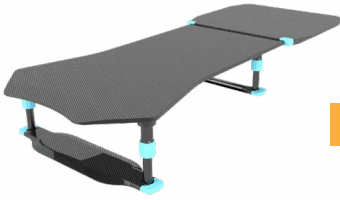

Component Codes

	Face Pad	M6531
	Face Pad Support	M6532
	Adjustable Assembly	M6533
	Base Board	M6534





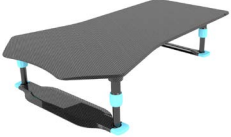



Retrograde IR Platform

AM0400 - AM0410 - AM0420 - AM0450

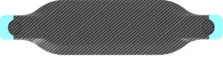
Product Codes			Carton Dimensions L x W x H (cm)	Carton Weight (kg)
	Retrograde IR Platform + Extension	AM0420	145 x 85 x 9	17
	Retrograde IR Platform without Extension	AM0400	145 x 85 x 9	14.5
	IR Platform Extension	AM0410	77 x 69 x 4	4.3
	Retrograde IR Platform - Narrow	AM0450	145 x 85 x 9	13.5

Component Codes

	Retrograde Main Platform	M3660
	Retrograde Main Platform - Narrow	M3650

	Front Base	M3662
	Front Base - Narrow	M3651
	Rear Base	M3663
	Leg	M3664
	Leg Extension	M3693
	Extension (Not compatible with AM0450 Retrograde Main Platform - Narrow)	AM0410

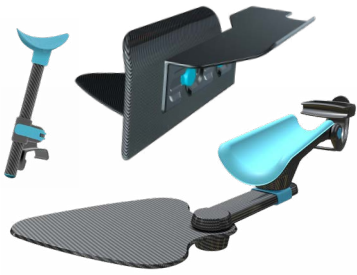

STARSystem
AM0160 - AM0100 - AM0140

Product Codes		Carton Dimensions L x W x H (cm)	Carton Weight (kg)
	STARSystem AM0160	80 x 40 x 28	8.2
	STARBoard + STARSupport AM0100	50 x 37 x 24	3
	STARTable AM0140	80 x 40 x 28	6.2
	Arm Support Pad AM0171	32 x 18 x 9	0.5
	STARSupport AM0130	24 x 23 x 27	0.6

Component Codes

STARBoard

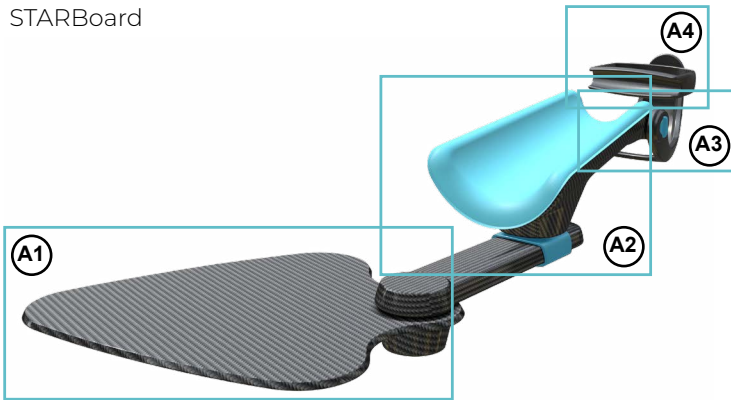

B C STARTable

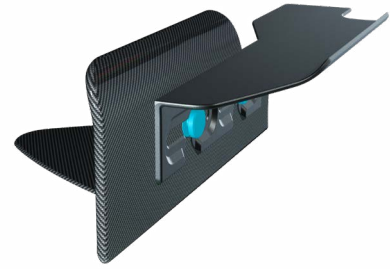

D STARSupport



STARBoard

A1

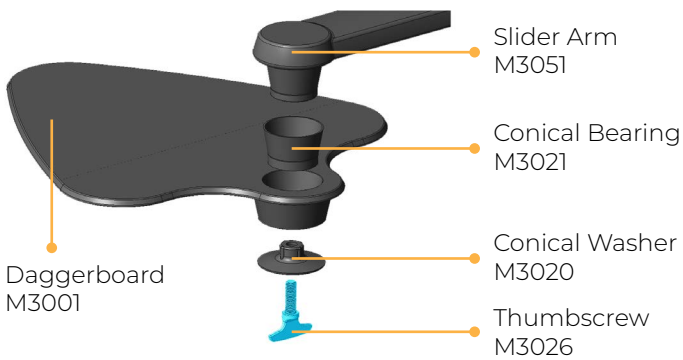

A2

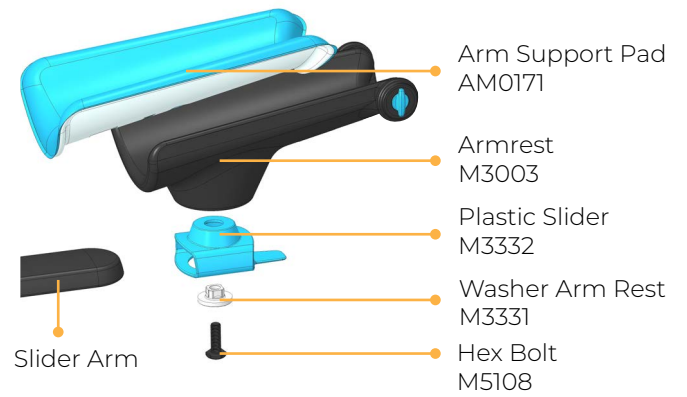

A3



A4



STARTable

(B) (C)

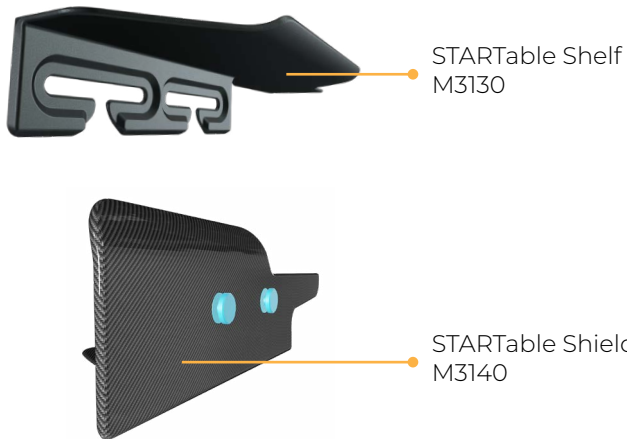

STARSupport

(D)



Maintenance Instructions

STARBoard

1

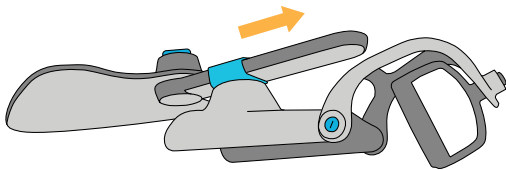

2

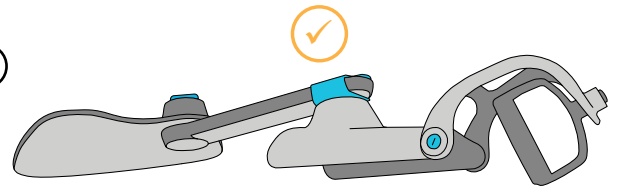

3

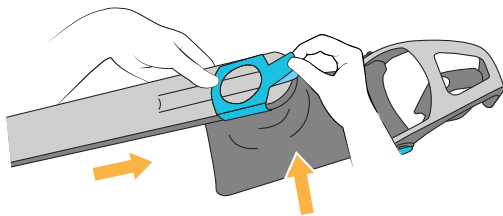

4

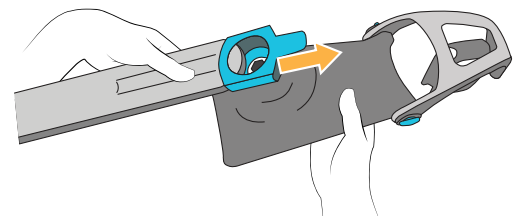

5

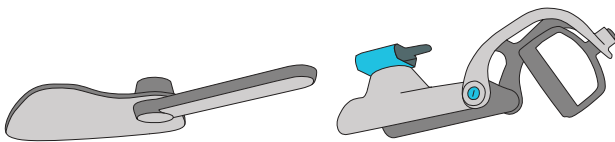

6

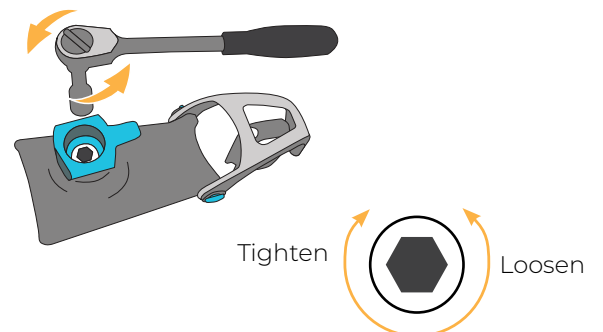

[adeptmedicaltraining.com
/product-maintenance-starsystem](https://adeptmedicaltraining.com/product-maintenance-starsystem)